

# ASSEMBLY INSTRUCTIONS

BUILDING

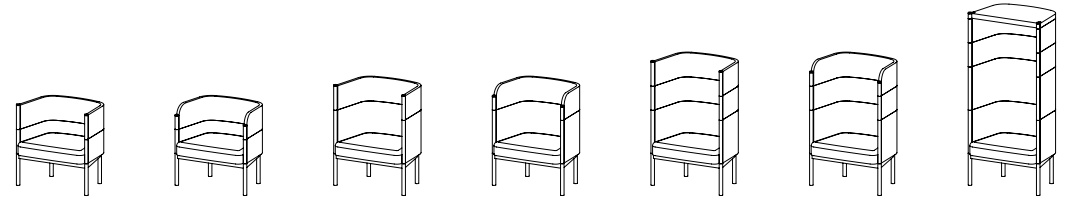

## COMPONENTS

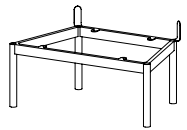

1 x Base

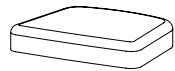

1 x Seat

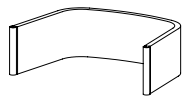

Module 1



Top

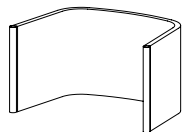

Module 2



2 x Inner tube



Module 3



6 x M6



2 x M6

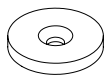

2 x Top cap

Required tools: hex key.

- 1 Slide the inner tubes into the frame and secure using a hex key and 2 x M6.

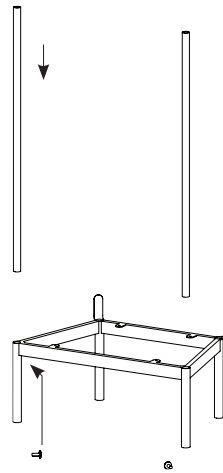

- 3 Slide the modules over the inner tube in the desired order. There are 3 top options.

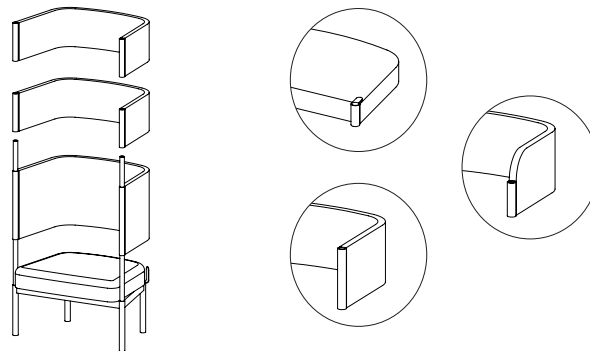

- 2 Put the seat in place and attach it to the frame using a hex key and 4 x M6.

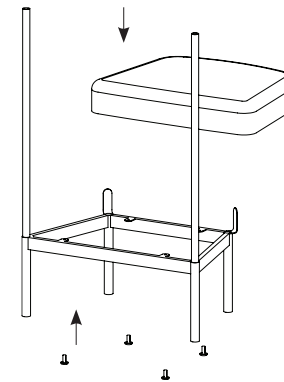

- 4 Finally attach the top caps using a hex key and 2 x M6.

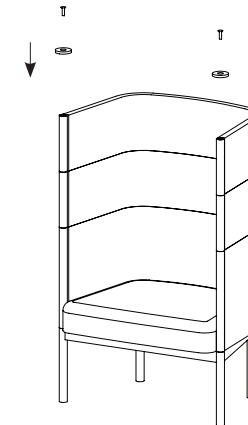

# MONTERINGSANVISNINGAR

BUILDING

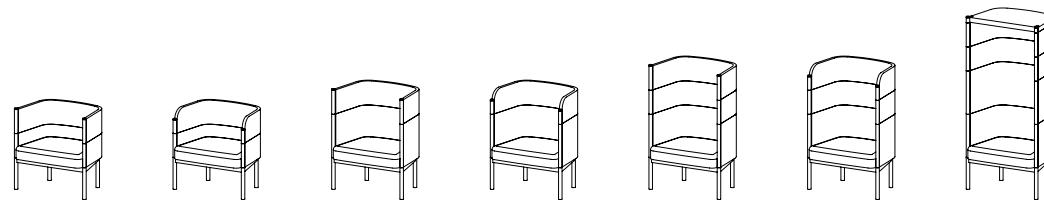

## KOMPONENTER

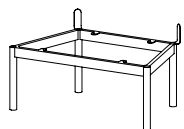

1 x Stativ



1 x Sits



Modul 1



Tak

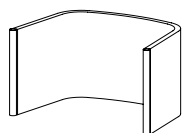

Modul 2



2 x Staplingsrör



Modul 3



6 x M6



2 x M6



2 x Låsbricka

1 Passa in staplingsrören i stativet och lås med 2 X M6. Använd en insexnyckel.

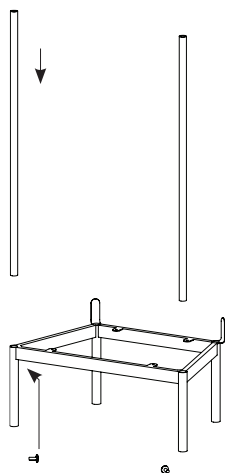

3 Placera modulerna över staplingsrören i önskad ordning. Observera att det finns tre olika varianter på avslut.

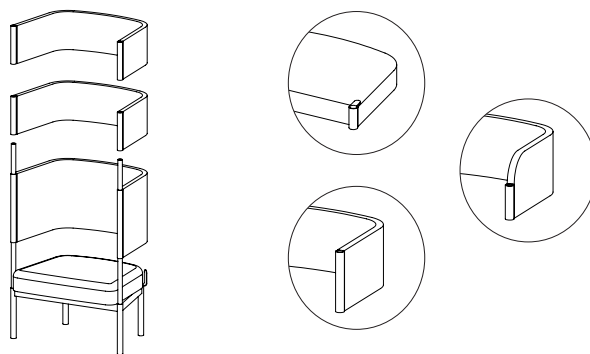

2 Passa in sitsen i stativet och fäst med 4 X M6. Använd en insexnyckel.

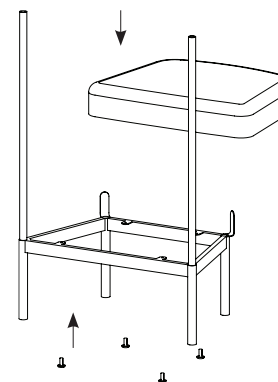

4 Fäst låsbrickorna med 2 X M6. Använd en insexnyckel.

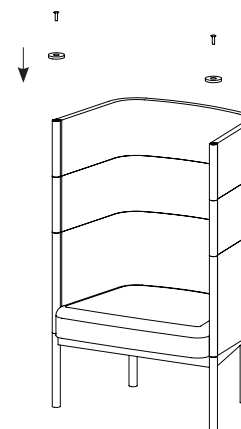

Verktyg för montering: Insexnyckel.